



Conn, TNC Male Crimp for RG174

2F1142

100308



Conn, TNC-Fem,
For Wilson400 Cable, Crimp

2F1144



Conn, TNC-Male,
For Wilson400 Cable, Crimp

2F1143



SMA Jack, Edge Mount Connector

2F1145

Crimp & Connector Guide



3301 East Deseret Drive, St. George, UT 84790
For additional Technical Support visit www.WilsonElectronics.com
or email at: tech@wilsonelectronics.com
Phone: 866-294-1660 Local: 435-673-5021 Fax: 435-656-2432
www.twitter.com/WilsonCellular www.facebook.com/WilsonCellular
CrimpConnector_Guide_Rev4_01.10.12



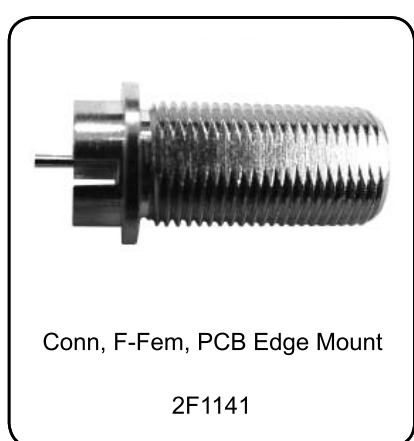
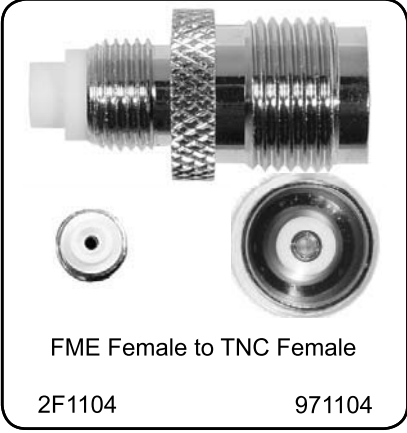
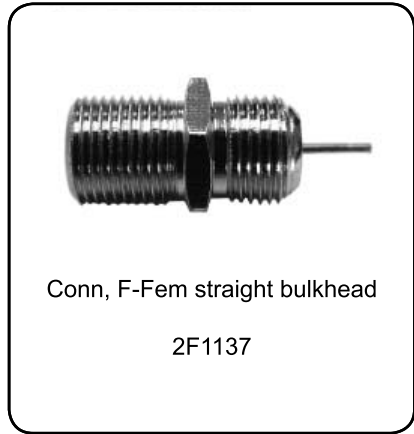
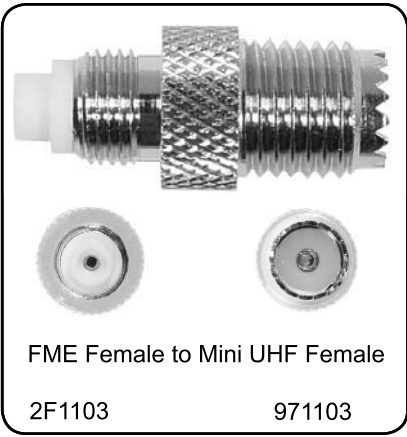



Conn, SMA-FEM, 50 OHM,
for PCB, SMT-Edge

110412



Conn Recept Coax Switching SMT

110588

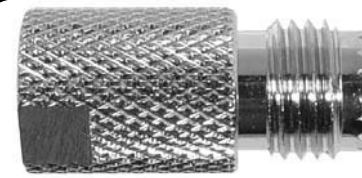

FME Male to Mini UHF Female

2F1110

971110

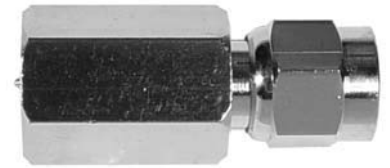

FME Male to SMA Male

2F1119

971119



Conn, FME-MAL,
for RG6 CBL, Crimp

110537



Conn, F-Fem, Panel, 1-Pin,
4-SCR

110624



FME Male to N Male

2F1113

971113



FME Female to FME Female

2F1121

971121

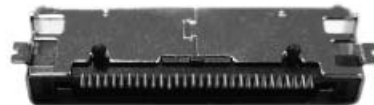

Conn, Female, for PCB, 30-Pin

110733



Mini USB Jack 5 Pin Connector

110579

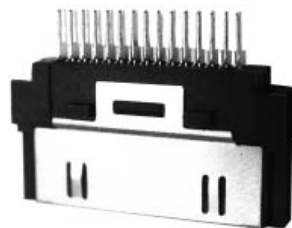

Conn, Male, for PCB, 30-Pin

110734

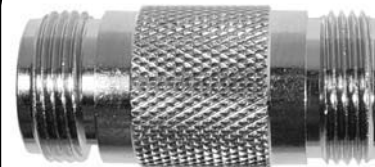

N Female to N Female

2F1117

971117



FME Male - TNC Male
Right Angle Connector

2F1127

971127



N Male to F Female Connector

2F1128

971128



SMA Male to RG58
Crimp Connector

2F1131

971131



Crimp Ferule for RG59 Cable

100282



Conn, FME-MAL, 50 OHM,
for PCB, Panel

110004



F Female to F Female Connector
for RG6 Cable

2F1129

971129



SMA Male to N Male Connector

2F1132

971132



Conn, N-Fem, for PCB,
Bulk-HD, 1-Pin

110002



Conn, DC-PWR, for PCB,
SMT, 4-Pin

110243



Conn, FME-MAL, 50 OHM,
for PCB, Panel

110256



F FEM to TNC Male Adapter

2F1130

971130



FME Female to
SMA Female Connector

2F1136

971136



Conn, DC-PWR, for PCB,
Panel, 2-Pin

110003



Conn, N-FEM, 50 OHM,
for PCB, Panel

110260



SMA Male Crimp for RG174 Cable

100229

971139



Conn, MMCX, for RG174 CBL, Crimp

100225



N Male Crimp for 9913 Cable

2F1109

971109



Reverse Polarity SMA Male Crimp

100223



SMA Female Crimp for RG174

100230



TNC Male Crimp for RG58 Cable

2F1111

971111



Mini UHF Male Crimp for RG58 Cable

2F1112

971112



Reverse Polarity SMA Female Crimp

100224

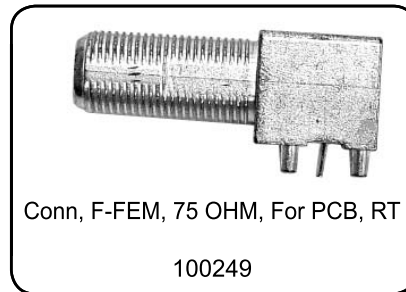

Conn, F-FEM, 75 OHM, For PCB, RT

100249

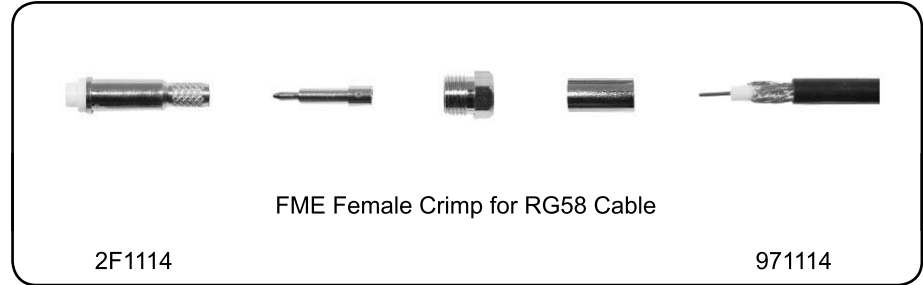

FME Female Crimp for RG58 Cable

2F1114

971114



Conn, TNC-FEM, 50 OHM, For PCB, RT

100250



FME Male Crimp for RG58 Cable

2F1115

971115

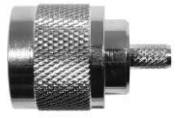

N Male Crimp for RG58 Cable

2F1116



971116



FME Female to RP - SMA Female Jumper (12 in RG174 Coax)

971123



Mini UHF Female Crimp for RG174 Cable

2F1118



971118



FME Female to SMA Male Jumper (6 in RG174 Coax)

2F1125

971125



FME Female Crimp for RG174 Cable

2F1120



971120



FME Female to RP - SMA Male Jumper (12 in RG174 Coax)

971122

5

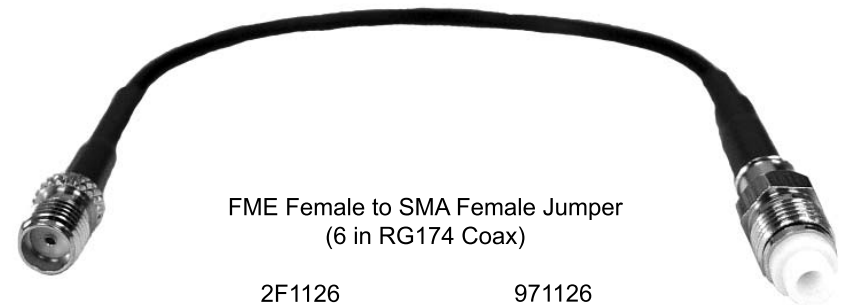

FME Female to SMA Female Jumper (6 in RG174 Coax)

2F1126

971126

6